

## INSTALLATION CERTIFICATE

The undersigned qualified installer attests to have personally fitted the here described vehicle security system following the manufacturer instructions.

By :

Sold on :

Type of product :

- 863
- 862
- 861

Vehicle :

**GEMINI Technologies S.p.A.**  
Via Luigi Galvani 12 - 21020 Bodio Lomnago (VA) - Italia  
Tel. +39 0332 943211 - Fax +39 0332 948080  
Web site: [www.gemini-alarm.com](http://www.gemini-alarm.com)



**863 - 863/24**  
**862 - 862/24**  
**861**

**INSTALLATION AND  
USE MANUAL**



Made in Italy

AC 2710/UK Rev. 01 - 02/12

**1.0 - PRELIMINARY ADVICE**..... PAGE 03

**USER MANUAL**

**2.0 - OPERATING DESCRIPTION**..... PAGE 03

2.1 - Complete system arming..... PAGE 04

2.2 - System arming with siren sound exclusion..... PAGE 04

2.3 - System arming with sensor and comfort control exclusion..... PAGE 04

2.4 - Passive arming..... PAGE 04

2.5 - Arming inhibit time..... PAGE 04

2.6 - System armed..... PAGE 05

2.7 - Alarm, inhibit time between alarms and alarm cycles..... PAGE 05

2.8 - System disarming..... PAGE 05

2.9 - Alarm memory..... PAGE 05

**3.0 - NEW PIN-CODE PROGRAMMING**..... PAGE 06

**4.0 - EMERGENCY DISARMING BY PIN-CODE**..... PAGE 07

**5.0 - GARAGE FUNCTION**..... PAGE 07

**INSTALLER MANUAL**

**6.0 - CONNECTOR TABLE**..... PAGE 08

**7.0 - CONNECTION FOR TURN SIGNALS ACTIVATION**..... PAGE 08

**8.0 - COMPLETE ELECTRIC DIAGRAM**..... PAGE 09

**9.0 - PROGRAMMABLE FUNCTIONS DESCRIPTION**..... PAGE 10

9.1 - Acoustic signalling..... PAGE 10

9.2 - Remote controlled panic alarm or car finder..... PAGE 10

9.3 - Current absorption sensor..... PAGE 10

9.4 - System self-rearming and door locking..... PAGE 10

9.5 - Passive arming..... PAGE 10

9.6 - Central door locking setting time..... PAGE 10

9.7 - Comfort closure control..... PAGE 10

9.8 - Double impulse in opening..... PAGE 10

9.9 - Supplementary siren output or boot opening..... PAGE 10

9.10 - Negative output selection (during alarm) for horns or additional siren..... PAGE 10

9.11 - Open door signaling during arming time..... PAGE 10

9.12 - Optical signal activation selection..... PAGE 10

9.13 - Doors push-buttons polarity selection..... PAGE 11

**10.0 - SYSTEM PROGRAMMING**..... PAGE 11

**11.0 - ADDING NEW DEVICES**..... PAGE 12

**12.0 - DELETING PROGRAMMED DEVICES**..... PAGE 13

**13.0 - ULTRASONIC VOLUMETRIC PROTECTION**..... PAGE 14

13.1 - Connection and positioning..... PAGE 14

13.2 - Sensor regulation..... PAGE 14

**14.0 - DIAGNOSTIC**..... PAGE 14

**15.0 - WARRANTY CONDITIONS**..... PAGE 15

**16.0 - TECHNICAL SPECIFICATIONS**..... PAGE 15

**17.0 - WASTE ELECTRICAL AND ELECTRONIC EQUIPMENT (WEEE) DIRECTIVE**.... PAGE 15

**1.0 - PRELIMINARY ADVICE**

Dear Customer, this manual has been written based on the complete system; some functions, electrical connections and other are not available in all models. For this reasons, in order to avoid repetitions in the manual, before installing your alarm model, you are kindly requested to verify it and refer to the suitable instructions.

**GEMINI 862:** same as 863 without self-powered battery.

**GEMINI 861:** same as 862 without electronic key and engine block.

In order to indicate to the installer and to the user some particular functions or connections, an icon symbology has been used, which is briefly described below:



**Indications useful for the user.**

This icon provides the user with indications for a diversified use of the system or it simply provides indications useful for the use.



**Indications useful for the installer.**

This icon indicates to the installer a diversified operating, according to the connection and the programming of the system or it simply provides indications useful for the installation.

**USER MANUAL**

**2.0 - OPERATING DESCRIPTION**

**PUSH-BUTTON nr. 1:**  
• **SYSTEM ARMING.**

**PUSH-BUTTON nr. 3:**  
• **SENSORS EXCLUSION.**  
• **PANIC ALARM or CAR FINDER.**  
• **SIREN CONTROL DURING ALARM CONDITIONS.**

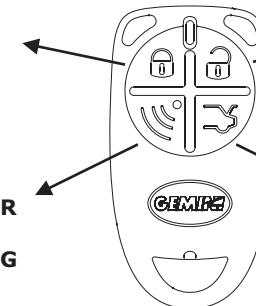

**PUSH-BUTTON nr. 2:**  
• **SYSTEM DISARMING.**  
• **SIREN SOUND EXCLUSION.**

**PUSH-BUTTON nr. 4:**  
• **BOOT OPENING.**

When batteries are almost uncharged, the LED will flash at every pressing of the radio control push button.

For battery replacement follow the indications reported below.

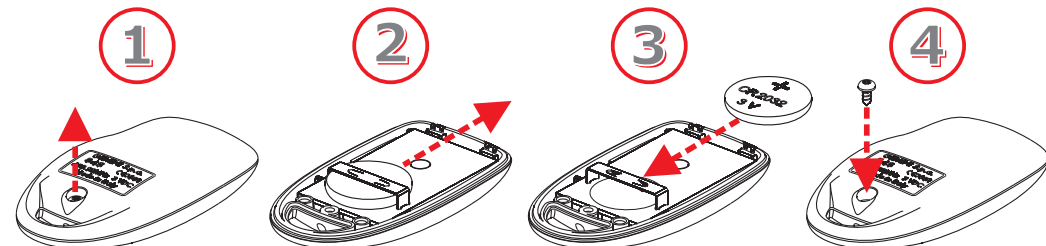

Use only batteries of CR2032 type; we suggest to not throw the exhausted batteries in the normal garbage bins, but to use the specific containers for their disposal.

## 2.1 - COMPLETE SYSTEM ARMING

Press the push-button nr.1 (padlock closed) of the remote control or insert the electronic key into the specific receptacle.

The system arming is confirmed by two acoustic signals and two flashes of the turn signals. The system has a 35" pre-arming "neutral time" (indicated by LED's permanent turning on).

## 2.2 - SYSTEM ARMING WITH SIREN SOUND EXCLUSION

This function allows the user to arm the alarm system, excluding the siren sound in case of a theft attempt.

To exclude the siren, proceed as follows:

- With the alarm system being disarmed, turn the ignition key to "ON" position; the status will stay on for about one second.
- During this time, push the button nr.2 (padlock opened) of the remote control.
- Go away from the vehicle and push the button nr.1 (padlock closed) of the remote control.
- The system will be armed with normal optical and acoustic signaling, although the latter will be not activated in case of an effraction attempt.

 The siren sound exclusion is bound to the single arming cycle. This function is applied close to the hospitals.

 The supplementary siren negative output (YELLOW-BLACK wire) is not excluded. Thus, in case of alarm, eventual supplementary modules (localizer, etc...) can be controlled.

## 2.3 - SYSTEM ARMING WITH SENSOR AND COMFORT CONTROL EXCLUSION

This function allows the user to arm the system with internal volumetric protection, external sensors (infrared wireless), positive with system armed (+A) and comfort function excluded.

To activate this function, the system should be disarmed and the ignition key turned to the "OFF" position; proceed as follows.

- Press the push-button nr. 1 of the remote; the system will be armed with normal optical and acoustic signaling.
- During the 35" of the arming neutral time, press the push-button nr.3 of the remote.
- One short turn signals flashing and the LED's turning off for one second indicate sensor exclusion.

 Sensors and comfot function exclusion is bound to the single arming cycle.

## 2.4 - PASSIVE ARMING

After the programming the alarm is set to be passively armed, about 30" after the vehicle switching off. One turn signals flash, two LED flashes and two acoustic signalling will be inicate the activation procedure starting.

 In case of alarm system passive arming, internal sensors and comfort output (automatic window closing) will be excluded . Moreover, the vehicle's door opening during the 30" before the passive arming, inhibit activation temporarily.

## 2.5 - ARMING INHIBIT TIME

The inhibit arming time lasts for approxiately 35" and is indicated by a illuminated status LED.

## 2.6 - SYSTEM ARMED

After the inhibit time the system is "armed" and it is ready to detect any theft attempt. When the system fully armed, the LED flashes.

## 2.7 - ALARM, INHIBIT TIME BETWEEN ALARMS AND ALARM CYCLES

As mentioned before, the alarm sysstem will indicate any theft attempt by optical/acoustic signals. After the alarm has been triggered, before another alarm cause, there are 5" of "neutral time" that allow to disarm the system by emergency pin-code.

 PIN-CODE changing is suggested, at user's discretion.

The alarm signalling has 8 cycles of 30" each for input and arming cycles, except the "starting attempt" and the system power supply "cut wires".

 It's possible cut off the alarm cycle without deactivating the system by pressing the push-button nr.3 of the remote control.

## 2.8 - SYSTEM DISARMING

Press the push-button nr.2 (padlock opened) of the remote control or insert the electronic key into the receptacle.

System disarming is confirmed by three siren acoustic signals and three flashes of the turn signals. If an alarm condition has occurred, it will be signalled by five turn signal flashes and five acoustic signals.

See relative paragraphs (2.9) for possible causes and signaling.

## 2.9 - ALARM MEMORY

In case of five turn signals flashes and five acoustic signals occurring at the system disarming, thanks to the LED's memory, it is possible to identify the cause which has generated the last alarm condition. Turn the vehicle ignition key in "ON" position and look at the vehicle status LED; It will start to blinks, shown the last alarm condition.

The optical signalling will be indicate for 5 times and this indication can be interrupted by turning the vehicle ignition key to "OFF" position.

The possible alarm trigger signaling are indicated in the table reported below.

LED SIGNALLING	ALARM CAUSE	Nr. OF ALARM
* * * ● * * *	Starting attempt (+15/54)	Infinite
* * * * ● * * * *	Doors opening	8
* * * * * ● * * * * *	Bonnet opening or external sensors	8
* * * * * * ● * * * * * *	Internal sensor	8
* * * * * * * ● * * * * * * *	Wirless magnetic contact	8
* * * * * * * * ● * * * * * * * *	Wirless infrared sensor (PIR)	8
* * * * * * * * * ● * * * * * * * * *	Absorption sensor	8
* * * * * * * * * * ● * * * * * * * * * *	Cut wires	Infinite
● LED OFF (2 seconds) * LED ON (1 second)		

### 3.0 - NEW PIN-CODE PROGRAMMING

The procedure to program pin-code is specified here below as previously described, it is better to personalize as customer has required.

In this example reported below, supposing that the pin-code is 5-4-6-7.



To carry out the operation successfully, make sure the required electrical connections (door push-button and positive under key) are complete.



During PIN-CODE programming phase, if flashes are more than 9, this phase will be invalid and the system will close the procedure.

- With the system being disarmed, open the driver side door and keep it open.
- Turn the vehicle ignition key to "ON" position.
- The status LED will be turned on for one second; during this period, push simultaneously the two buttons of the remote control with embossed the padlocks.
- After this procedure, two acoustic signals will be sent out, one with acute tone and the other with loud tone and the LED will lighted on.
- Push simultaneously the two buttons of the remote control with embossed the padlocks; the LED will be turned off.
- Turn the vehicle ignition key to "OFF" position.
- After a four second pause, status LED will start with the first sequence of 9 flashes.
- At the fifth LED flashing (corresponding at nr.5, first digit of the PIN-CODE), push and release the button on the status LED.
- After a four second pause, status LED will start with a new sequence of 9 flashes.
- At the fourth LED flashing (corresponding at nr.4, second digit of the pin-code) push and release the button on the status LED.
- After a four second pause, status LED will start with a new sequence of 9 flashes.
- At the sixth LED flashing (corresponding at nr.6, third digit of the pin-code) push and release the button on the status LED.
- After a four second pause, status LED will start with the last sequence of 9 flashes.
- At the seventh LED flashing (corresponding at nr.7, fourth digit of the pin-code) push and release the button on the status LED.
- The system will indicate the end of the procedure by two acoustic signal with low tone and one with high tone.

### 4.0 - EMERGENCY DISARMING BY PIN-CODE

The procedure for emergency disarming by pin-code is following, reported below.

Kindly note that the standard pin-code programmed is of the four digit 1-1-1-1.

The same number used for pin-code programming (5-4-6-7) has been used also for emergency disarming example.



During PIN-CODE disarming phase, if flashes are more than 9, the procedure will be interpreted as a theft attempt.

- Cause an alarm condition.
- Leave the system triggering for the standard alarm timing (about 30 seconds) and wait for the "inhibit time between two alarm signalling" (LED switched off for 5").
- During this period push and release the push-button of the status LED.
- From now and on the system is in the "emergency procedure disarming".
- After about 4 seconds the first 9 flashing sequence starts.
- At the fifth LED flashing (corresponding at nr.5, first digit of the pin-code), push and release the button on the status LED.
- The LED will be switch off for about 4 seconds than a new 9 flash sequence will start.
- At the fourth LED flashing (corresponding at nr.4, second digit of the pin-code), push and release the button on the status LED.
- The LED will be switch off for about 4 seconds than a new 9 flash sequence will start.
- At the sixth LED flashing (corresponding at nr.6, third digit of the pin-code) push and release the button on the status LED.
- The LED will be switch off for about 4 seconds than a new 9 flash sequence will start.
- At the seventh LED flashing (corresponding at nr.7, fourth and last digit of the pin-code) push and release the button on the status LED.
- If the code is right, the end of the emergency disarming by pin-code will be indicated by the alarm with visual/acoustic signalling.
- Vice versa, if the inserted numbers are wrong, the alarm will start triggering again; in this case, repeat all procedure.

### 5.0 - GARAGE FUNCTION



This function is used ONLY if "system self-arming" or "passive arming" functions have been programmed.

This function is used when the alarm disarming is required, e.g. for maintenance, without any intervention to the previous programming.

For procedure activation follow the indications reported below:

- Arm the system and wait for the end of arming neutral time.
- Put the electronic key into the specific receptacle.
- Three acoustic signals of the siren and three optical signals of turn signals will indicate the system's disarming and the above mentioned function deactivation.
- To restore normal operating of programmed functions, arm the alarm via the remote control.

## 6.0 - CONNECTOR TABLE

POSITION	WIRE FUNCTION	WIRE COLOUR
- 1 -	Bonnet push-button negative input	GREEN
- 1 -	External sensor negative input	GREEN-BLACK
- 2 -	Doors push-button input	GREEN-BROWN
- 3 -	Positive under key	BLACK marked "G"
- 4/5 -	Siren output	-----
- 6 -	Ground	BLACK marked "M"
- 7 -	Supplementary siren/vehicle claxson or boot opening	YELLOW-BLACK
- 8 -	Positive output with system armed (+A)	PINK
- 9 -	LED and receptacle for electronic key negative output	BLACK and BROWN
- 10 -	LED positive output	RED
- 11 -	Positive	BLACK marked "R"
- 12 -	Antenna	BLACK
- 13 -	Receptacle for electronic key input	GREEN
- 14 -	Engine block	BLACK marked "H"
- 15 -	Engine block	BLACK marked "H"
- 16 -	Turn signals positive/negative output	ORANGE
- 17 -	Turn signals positive/negative output	ORANGE
- 18 -	Turn signals positive/negative common	WHITE-RED
- 19 -	CDL	RED-GREY
- 20 -	CDL	RED-BROWN
- 21 -	CDL	RED-BLUE
- 22 -	CDL	YELLOW-BLUE
- 23 -	CDL	YELLOW-BROWN
- 24 -	CDL	YELLOW-GREY

## 7.0 - CONNECTION FOR TURN SIGNALS ACTIVATION

Connection and programming must be made according to the turn signals connection mode (standard or hazard), as indicated in the installation sheets.

The "standard configuration" module is set for connections as shown in the first box.

To modify configuration from "standard" to "impulse", please follow instructions given in the programming paragraph and then proceed with wiring connections as shown in the second box.

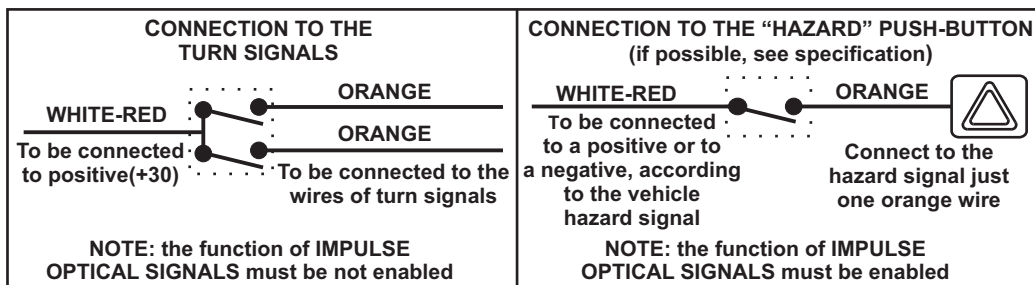

## 8.0 - COMPLETE ELECTRIC DIAGRAM

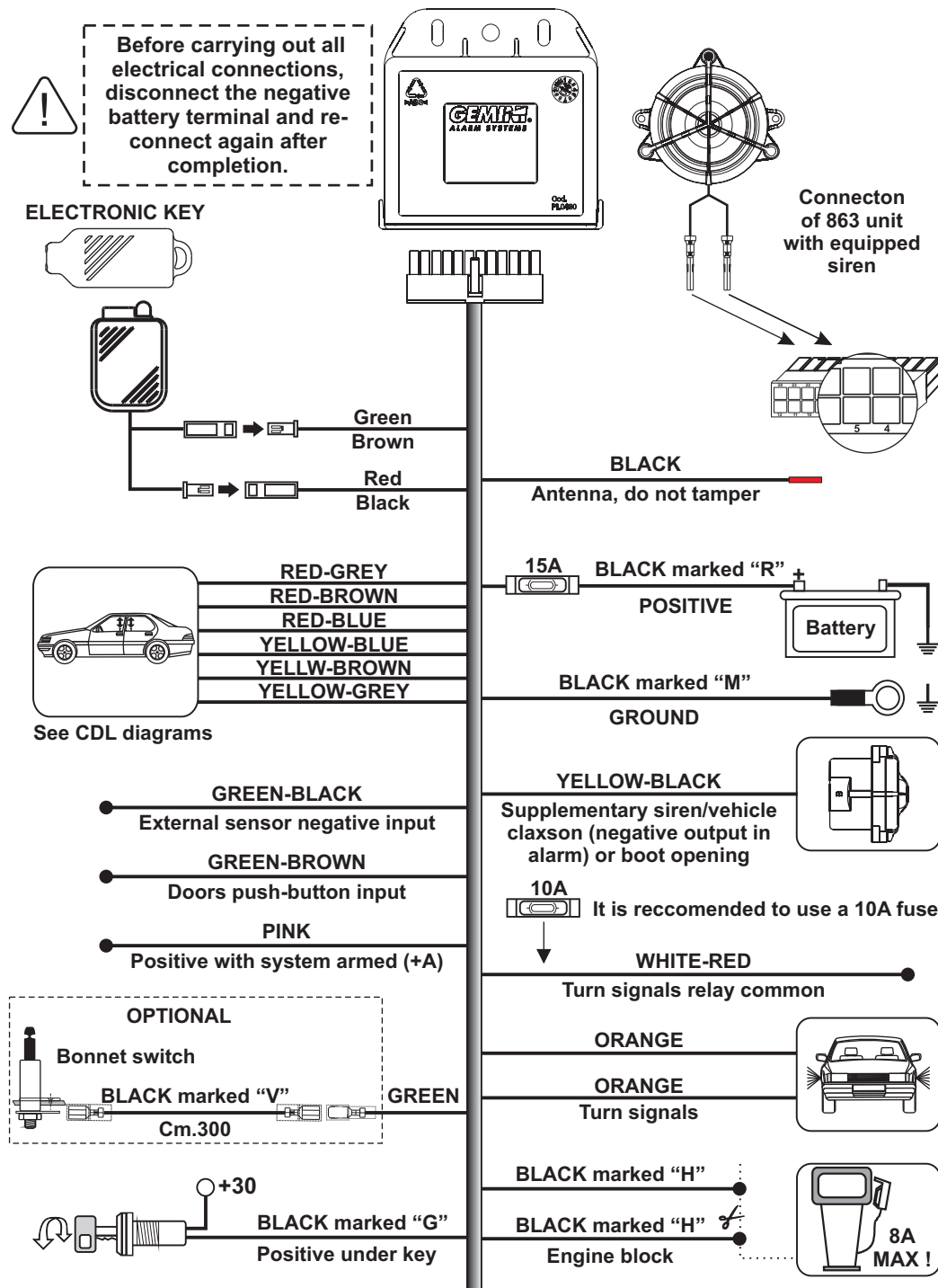

## 9.0 - PROGRAMMABLE FUNCTIONS DESCRIPTION

In this chapter various functions of the system are concisely described; for programming please follow the instruction given in paragraph "SYSTEM PROGRAMMING".

### 9.1 - ACOUSTIC SIGNALLING

This function activates acoustic signals during system arming (2) and disarming (3).

### 9.2 - REMOTE CONTROLLED PANIC ALARM

According to the programming, this function allows to:

- Press the "panic button" of radio control in order to activate the siren for 30" (remote controlled panic alarm).
- Being the system armed, press the "panic button" of radio control in order to activate for few seconds the siren and the turn signals (car finder).

### 9.3 - CURRENT ABSORPTION SENSOR

This function activates the system anytime a voltage sudden change in the vehicle's electrical circuit is occurring.

Before activating of the current absorption sensor, it is suggested to consult the specific rules being in force in your country (noise pollution).

### 9.4 - SYSTEM SELF-REARMING AND DOOR LOCKING

This function allows vehicle's protection in case the user disarms accidentally the system.

Thus, the system will be automatically rearmed after 35", if no intervention on the vehicle is done (i.e. door opening, engine start).

Together with the system self-rearming, the automatic door locking of the vehicle is done when running.

Being closed all the doors of the vehicle, turn the ignition key to "ON"; after 20", all doors will be locked.

By turning the ignition key to "OFF", all doors of the vehicle will be automatically unlocked.

### 9.5 - PASSIVE ARMING

Function that allows to have the system active 35" after the engine switching "OFF".

If you open a door during this period, the procedure will be interrupted till the door is closed.

### 9.6 - CENTRAL DOOR LOCKING SETTING TIME

Function that allows to select the CDL closure time.

### 9.7 - COMFORT CLOSURE CONTROL

This function allows activating the comfort control (window closing) when the system is armed.

### 9.8 - DOUBLE IMPULSE IN OPENING

This function activates twice the opening control and it is used on vehicles with diversified opening.

### 9.9 - SUPPLEMENTARY SIREN OUTPUT OR BOOT OPENING

This function, once connected, can activate the supplementary siren or open the trunk (remote control button with embossed trunk icon).

### 9.10 - NEGATIVE OUTPUT SELECTION (DURING ALARM) FOR HORNS OR ADDITIONAL SIREN

Depending on connection, this function can activate the output for the siren (continuous tone) or for the horn (intermittent tone).

### 9.11 - OPEN DOOR SIGNALING DURING ARMING TIME

This function activates for few seconds the siren, if a door is open being the system armed.

### 9.12 - OPTICAL SIGNAL ACTIVATION SELECTION

This function activates the optical signaling, according to the connection. It should be activated in some particular vehicles on which connection is made directly on the wire from the "hazard" button..



When the optical pulse signaling feature is activated, the blinkers will ONLY emit optical signals during an alarm cycle.

## 9.13 - DOORS PUSH-BUTTONS POLARITY SELECTION

This function modifies the alarm input signal (positive or negative) according to the signal from the door's button.

## 10.0 - SYSTEM PROGRAMMING



Pay attention to not modify the functions which have been programmed during the installation.

The system has been previously programmed with standard configuration during manufacturing procedure by Gemini.

For programming modification proceed as follows:

- With the system being disarmed, turn the vehicle ignition key to "ON" position.
- The status LED stay on for one second; during this time, push together the two buttons of the remote control with embossed the padlocks (button 1 or 2).
- Starting of programming procedure is indicated by two acoustic signals, one with high tone and one with loud tones, furthermore the status LED turns ON.
- To able and disable the functions, follow the below table, take into consideration that every time the push button of transmitter is pressed, the system goes to the following function. Furthermore, according to the button being pressed (button 1 or 2), two different acoustic signals are emitted.



By turning the ignition key to "OFF" in any moment of the programming procedure, the latter will stop and successive functions will remain unchanged.

FUNCTION	STATUS	BUTTON "1"	BUTTON "2"
Arming/disarming acoustic signalling	Enabled	Enable	Disable
Panic alarm or car finder	Enabled	Enable panic	Enable car finder
Current absorption sensor	Disabled	Enable	Disable
System self-rearming	Disabled	Enable	Disable
System passive arming	Disabled	Enable	Disable
Setting of opening/closing time (1" or 6")	Selected 1"	Enable 6"	Enable 1"
25" comfort closure	Disabled	Enable	Disable
Lock double impulse in opening	Disabled	Enable	Disable
Selection of supplementary siren or boot opening by remote	Enabled supplementary siren	Enable boot opening	Enable supplementary siren
Selection of continuous sound (supplementary siren) or alternate (vehicle's claxon)	Enabled continue sound	Elternate sound (vehicle's claxon)	Continue sound (siren)
"Doors opened" signalling during system arming	Disabled	Enable	Disable
"Standard" or "impulse" optic signalling activation	Enabled "standard"	Enable "impulse"	Enable "standard"
Selection of doors input polarity	Enabled negative polarity	Enable positive polarity	Enable negaive polarity

- Once the last function has been programmed, the alarm will confirm that the programming has been disabled with two acoustic signals with low tone, one acoustic signal with high tone, furthermore the LED will be turned off.
- Turn the vehicle ignition key to "OFF" position.

## 11.0 - ADDING NEW DEVICES



To carry out the operation successfully, make sure the required electrical connections (door push-button, bonnet push-button and positive under key) are complete.



Storing memory is for 50 devices.  
If an extra device is added, it automatically deletes the first device programmed in the system memory.

To activate the procedure proceed as follows:

- With system disarmed, open the driver side door and the bonnet and leave them open.



The following operations must be carried out within four seconds otherwise the procedure is invalidated.

- Turn ignition key "ON-OFF"- "ON-OFF"- "ON-OFF"- "ON".
- At the fourth rotation, leave it "ON".
- To confirm it has entered in the self-learning mode of new control devices, magnetic contacts, opening detectors or infrared sensors the system gives two acoustic signals (one high and one low-pitched).



Do not close the bonnet otherwise all previously programmed devices are erased as described in the next paragraph.

- The system is ready to receive the device codes.
- According to the device to be stored in memory, press the button nr.1 of the remote, insert the electronic key into the receptacle, make the magnetic contact transmit (bring contact and magnet close together and then move apart), press the push-button on the opening detector or make the infrared sensor transmit (see sensor instructions).
- Each time a device is learned a high-pitched signal sounds and the status LED flash briefly.
- Repeat this procedure to program other devices.
- Turn ignition key "OFF".
- To confirm the end of the procedure a low-pitched signal sounds.

## 12.0 - DELETING PROGRAMMED DEVICES



To carry out the operation successfully, make sure the required electrical connections (door push-button, bonnet push-button and positive under key) are complete.

All device previously programmed in the memory, such as control devices, magnetic contacts, opening detectors or infrared sensors, can be erased.  
To clear memory proceed as follows.

- With system disarmed, open the driver side door and the bonnet and leave them open.



The following operations must be carried out within four seconds otherwise the procedure is invalidated.

- Turn ignition key "ON-OFF"- "ON-OFF"- "ON-OFF"- "ON".
- At the fourth rotation, leave it "ON".
- To confirm it has entered in the delete mode, the system gives two acoustic signals (one high and one low-pitched).
- Close the bonnet; the LED will be steady "ON".
- Keep the bonnet closed (approx. 8 sec.) until the devices are completely deleted.



If the bonnet is opened before 8 seconds, the devices will not be deleted.

- The end of the procedure is indicated by the LED turnings OFF and one long low-pitched acoustic signal.
- Turn ignition key "OFF".

## 13.0 - ULTRASONIC VOLUMETRIC PROTECTION

### 13.1 - CONNECTIONS AND POSITIONING

Insert the WHITE connector in the the “W” socket on the control unit.  
Insert the RED connector in the “R” socket on the control unit.  
Install the transducers of the ultrasonic sensors in the uppermost part of the windscreen internal pillars, away from the aeration inlets and orient them towards the center of the rear window.

### 13.2 - SENSOR ADJUSTMENT

In case you don't want to activate the diagnostic procedure, to check sensitivity level proceed as follows:

- With the alarm system disarmed, roll down the front window about 20 cm.
- Adjust trimmer at a medium setting.
- Close all doors, bonnet and boot and arm the system.
- During the system inhibit arming time introduce an object in the cabin through the window and move it around; the status LED will turn off to signal a presence.
- If sensinty lelvel is too high or too low, readjust the trimmer and repeat the above procedure.

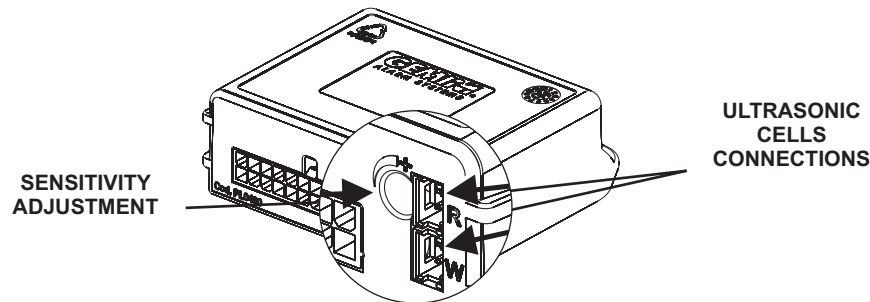

## 14.0 - DIAGNOSTIC



By activating the diagnostic procedure, the system returns to the Factory default setting.  
This procedure must therefore only be used in case of need, before programming the system or changing the pin-code.

To activate procedure proceed as follows:

- Switch-off system power supply.
- Push and keep pushed the the status LED push-button or short-circuit the RED and BLACK wires of the 2-way LED connector.
- Switch the system on; once the alarm system is powered, 4 acoustic signals will sound and the turn indicators will flash 4 timese.
- By opening a vehicle's door, the siren will be activated for 2" while by activating any other device, at every receiving of alarm or signals from electrical connections (i.e. hood button), one turn signal flashing and one acoustic signal will be sound
- Release the state LED button or remove the short circuit, previously created.
- One turn signal flashing and one acoustic signal will indicate the end of diagnostic procedure.

## 15.0 - WARRANTY CONDITIONS

This product is guaranteed to be free from manufacturing defects for a period of 24 months from the installation date shown on this warranty, in compliance with the Directive 1999/44/CE.  
Please fill-in entirely the guarantee certificate included in this booklet and do NOT REMOVE the guarantee label from the device.  
The warranty will become void if labels are missing or torn, if the installation certificate is not fully compiled or if the enclosed sale document is missing.  
The guarantee is valid exclusively at authorized Gemini Technologies S.p.A. Service Centers.  
The manufacturer declines any responsibility for eventual malfunctions of the device or any damage to the vehicle electrical system due to improper installation, use or tampering.  
This alarm system is solely intended to be a theft-deterrent device.

## 16.0 - TECHNICAL SPECIFICATIONS

Power supply 863 - 862 - 861	12 Vdc
Power supply 863/24 - 862/24	24 Vdc
Current absorption @ 12Vdc with system armed and LED flashing	15 mA
Working range temperature	From -30°C a +70°Cto
Turn signals relay contact capacity	8 A at 20°C
Engine immobiliser relay contact capacity	8 A at 20°C
Alarm cycle duration	30 sec.
Maximum positive current output when armed (+A)	10 mA
Additional siren output current capacity	5 A

## 17.0 - WASTE ELECTRICAL AND ELECTRONIC EQUIPMENT (WEEE) DIRECTIVE

The present device does not fall within the scope of Directive 2002/96/EC on Waste Electrical and Electronic Equipment (WEEE) as specified in art. 2.1 of L.D. no. 151 of 25/07/2005.